

HOW TO LOAD TRAILER FOR HEAVYWEIGHT GORILLA AIRBAGS

1. Load first units tightly against railcar bulkhead.
2. Load each successive row TIGHTLY against the previous row.

NOTE: The proper number and location of airbag(s) are determined by your specific application and can be obtained by contacting your Shippers representative.

3. Use only the Shippers inflator kit and inflator tips.

⚠ CAUTION ⚠ Read operating and safety instructions before using inflator kit.

4. Position the airbag approximately 1" above the floor to keep it from rubbing in transit and remove all the wrinkles.

Contact your local Shippers Products representative for proper inflation procedures.

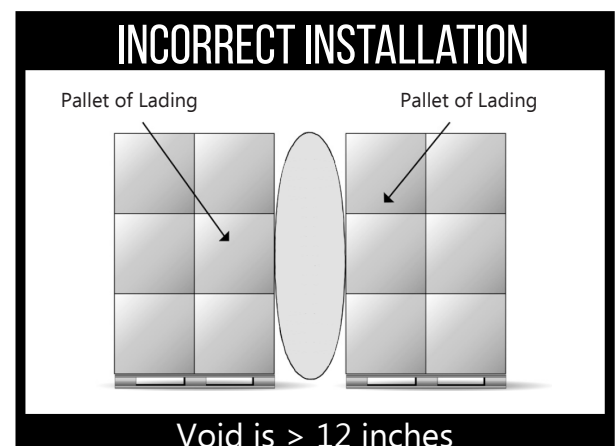
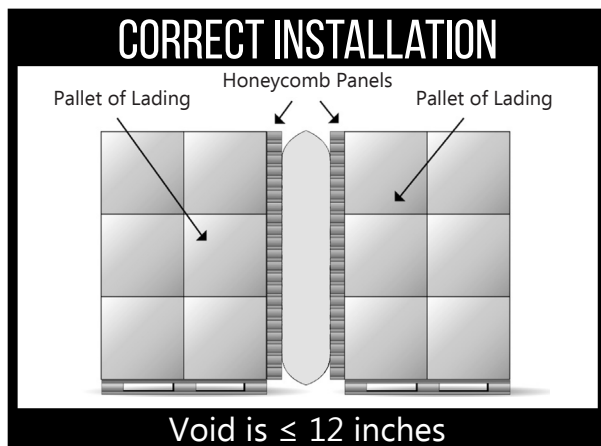
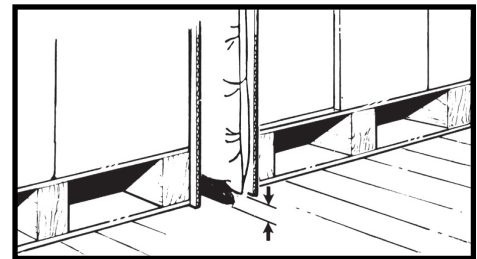
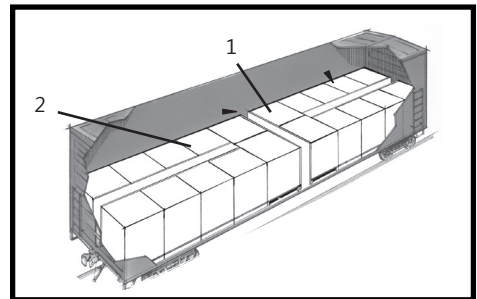
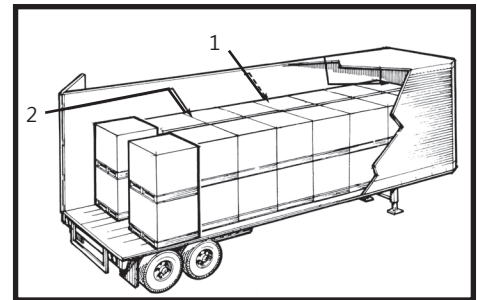

Narrow the void whenever possible by:

- Using honeycomb panels. (see above diagram)
- Turning the pallets (pinwheel) where the airbags are applied
- Contact your Shippers representative for other possible solutions

- NEVER inflate LEVEL 2 airbags over 5 PSI
- NEVER inflate LEVEL 3 airbags over 8 PSI
- NEVER inflate LEVEL 4 & 5 airbags over 10 PSI
- Exceeding the maximum air pressure stated on the airbag may cause the bag to burst

INFLATING HEAVYWEIGHT GORILLA AIRBAGS

1. Set air compressor regulator to appropriate settings. Additional assistance is available from a Shippers representative.

⚠ CAUTION ⚠ Please contact your Shippers representative to determine what the best PSI level is for your airbags.

2. Open valve cap and ensure that the valve is in the closed position by rotating the blue cross clockwise.

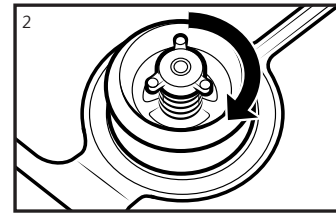

⚠ IMPORTANT ⚠ Valve must be in CLOSED position for bag to inflate.

3. Attach TX tip to the valve by pulling up on the black ring, place TX tip over the valve and push down the black ring to lock the inflator on to the valve. Squeeze inflator trigger to begin inflation.

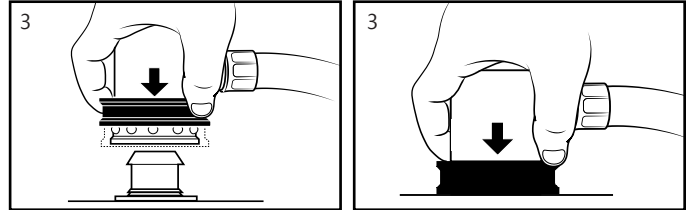

4. Refer to your Shippers inflator kit instructions for inflator operation instructions to inflate airbag.

5. To deflate, simply press and turn the blue cross counterclockwise and gently push the airbag for quick deflation.

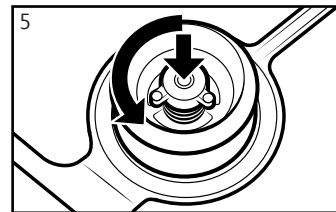

SAFETY & WARNINGS

1. Always wear safety glasses with side shields which conform to ANSI standard Z87.1 or EN166.
2. Never use air source for cleaning.
3. Never exceed maximum operating pressure stated on the airbag.
4. Never point inflator or inflation device towards face or body.
5. Only use Shippers Products inflators to inflate airbags.
6. Do not submerge the airbag or inflator in water.
7. Store the airbag and inflator in a dry area. Do not operate or expose inflator to wet weather elements.
8. Failure to follow these safety instruction could result in serious injury.

SHIPPERS PROMISE

We'll be your lowest cost supplier by...

- **Lowering your total costs** by preventing damages and improving the arrival condition of your products
- **Increasing** your productivity
- **Simplifying** your purchases with the most extensive range of dunnage air bags and inflation devices in the industry

We'll guarantee your satisfaction with...

- **The highest quality products** made in our own North American ISO9001 facilities
- Our commitment to on-going **product innovation and continuous process improvement**
- **On-site sales** and load planning assistance
- Supervised installation, loading procedures and safety training- custom **fit for your business**

We'll be easy to do business with...

- The most **highly trained load securement specialists** in our industry
- Our **professional and responsive** customer service teams
- **Fast shipping** from stock in our North American facilities
- The capability to **lower your supply chain risk**

Please contact Customer Service or Sales Representative if you have any questions.